

[Home](#)

[About CODI](#)

[About Baan Mankong](#)

[Results](#)

[Strategic Plans](#)

[Participatory Approach](#)

[Types of Development](#)

[Community Architects](#)

[Housing Prototypes](#)

[Self-Build Network](#)

[Humanitarian Relief Projects](#)

[Contact](#)

## Bang Bua Co-op Plans and Section

### 1-Story Detached House

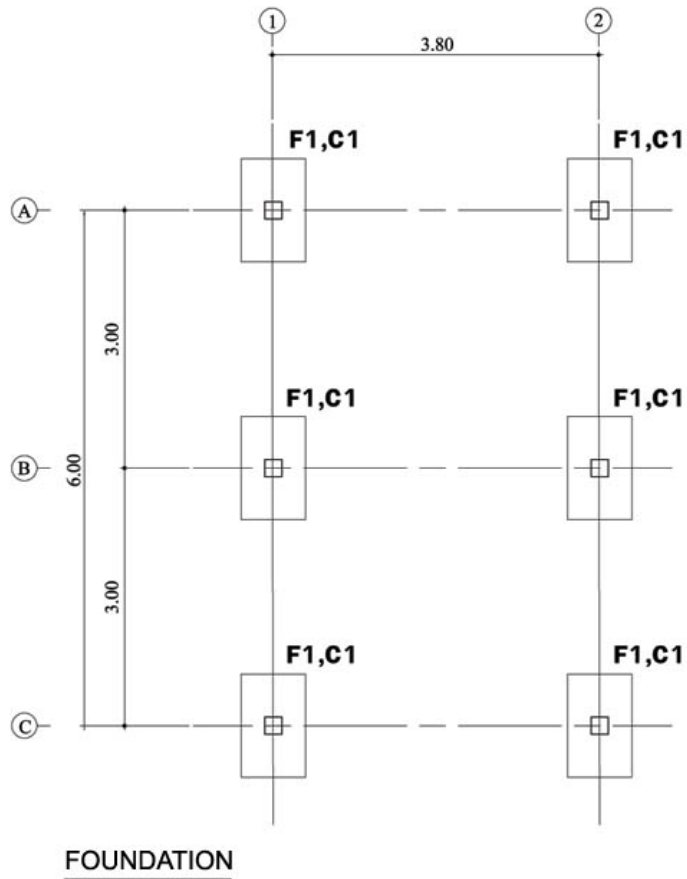

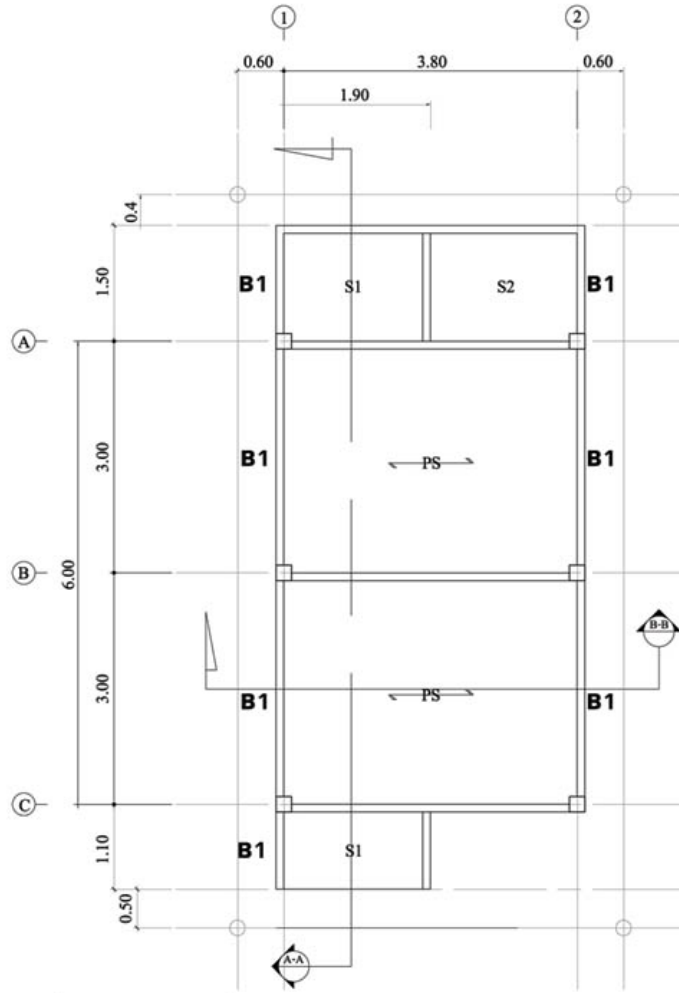

**GRADE BEAMS**

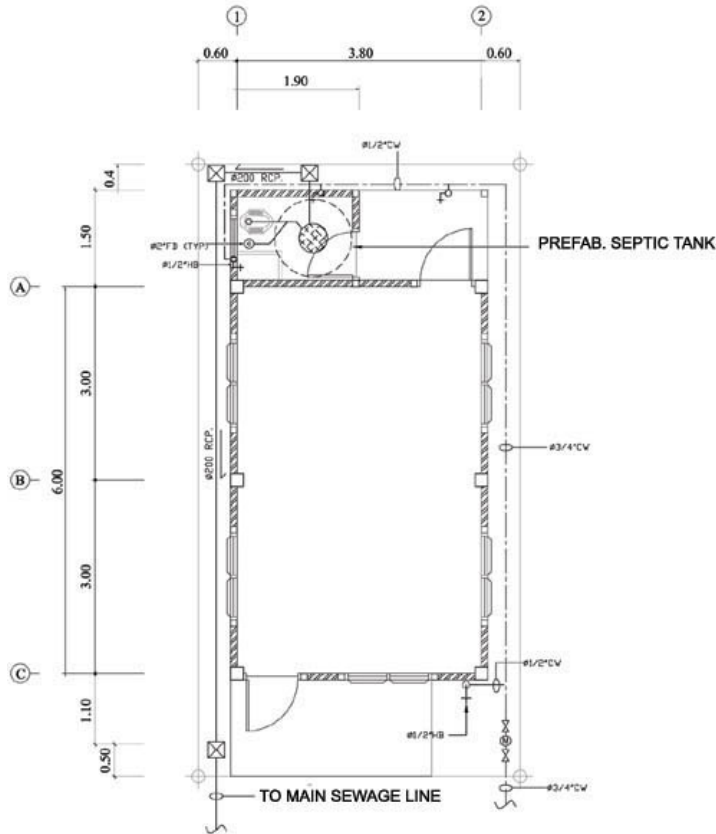

**PLUMBING PLAN**

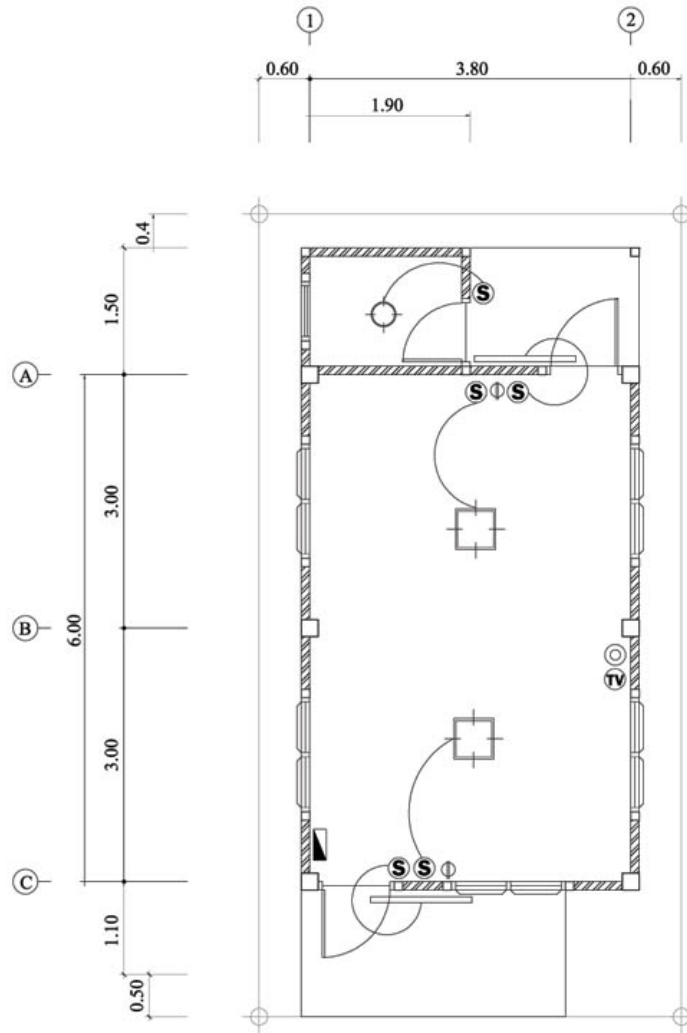

**ELECTRICAL**

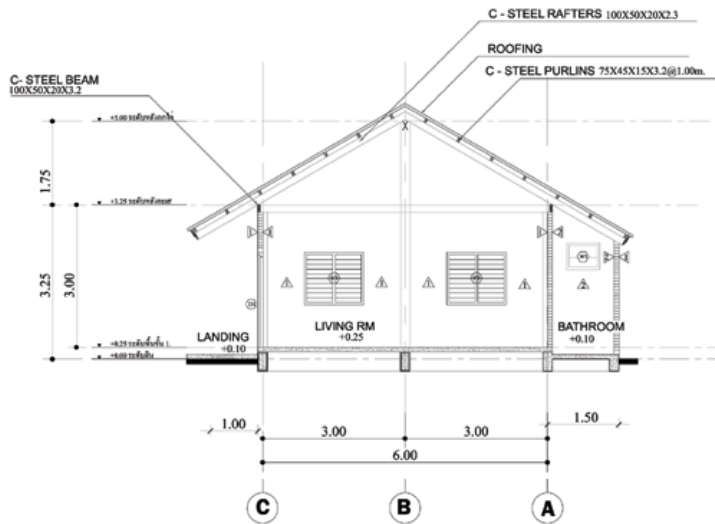

**SECTION A-A**

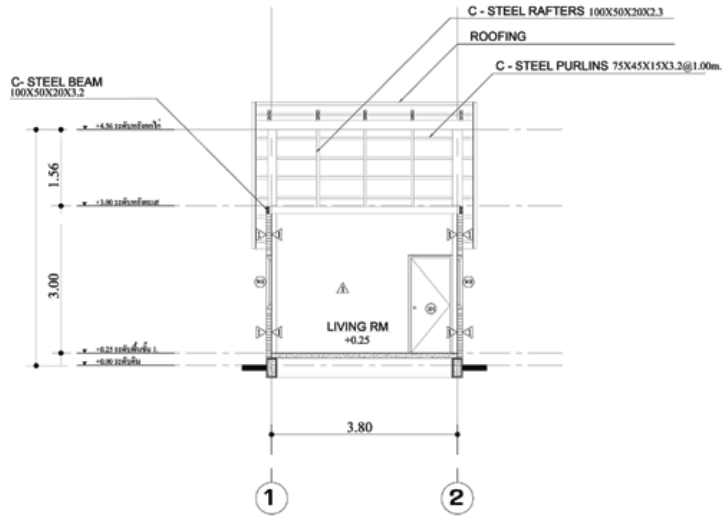

SECTION B-B

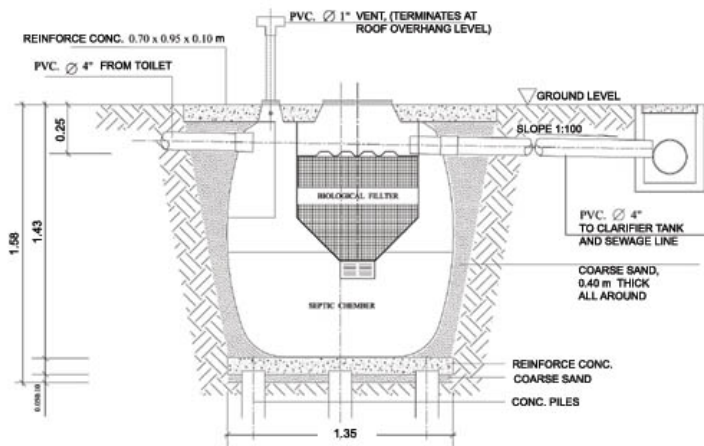

SEPTIC TANK SECTION

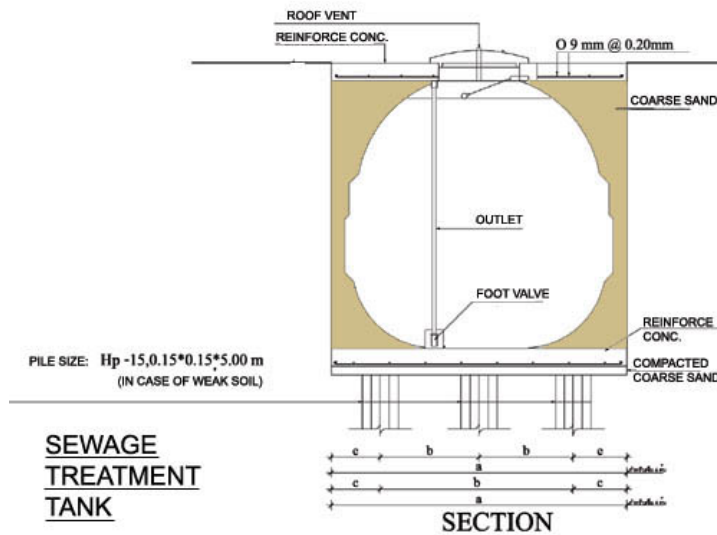

SEWAGE TREATMENT TANK SECTION